



KROHNE

▶ measure the facts

Pressure measurement

Product overview

ETA Process Instrumentation

www.etapii.com
sales@etapii.com
tel 978.532.1330

New England

Martech Controls

www.martechcontrols.com
sales@martechcontrols.com
tel: 315.876.9120

Upstate New York



Contents

5	Product selection
6-7	Technology driven by KROHNE
8-11	Process pressure measurement
12-13	OPTIBAR 3050 series
14-19	Differential pressure flow measurement
20-27	Hydrostatic pressure level measurement
28-31	Technical data
32-33	Communication technology
34-35	Services
36-37	Calibration

KROHNE trademarks:

KROHNE
measure the facts
CalSys
CARGOMASTER
EcoMATE
EGM
KROHNE Care
M-PHASE
OPTIBAR
OPTIBATCH
OPTIBRIDGE
OPTIFLEX
OPTIFLUX
OPTIMASS
OPTISENS
OPTISONIC
OPTISOUND
OPTISWIRL
OPTISWITCH
OPTISYS
OPTIWAVE
PipePatrol
WATERFLUX
SENSOFIT
SMARTMAC
SMARTPAT

Trademarks of other owners:

Amphenol
Bluetooth®
EtherNet/IP™
FDT Group
FOUNDATION™ fieldbus
HART®
HASTELLOY®
Metaglas®
PACTware
PROFIBUS®
PROFINET®
VARIVENT®



KROHNE – your global partner

KROHNE is your reliable partner for process instrumentation and automation. As our client, you benefit from our ability to solve your applications with matching measurement solutions; we offer a complete product portfolio, industry specific system solutions and complementary services for instrumentation projects of any size.

By having specialised in industrial process measurement since 1921, we have gained an enormous amount of application knowledge in various industries that is integrated into our products, solutions and services. We have truly mastered the physical principles our meters are based on: our ability to utilise physical effects and to find a matching measuring solution time after time are the reasons we are trusted by clients worldwide. The primary measured value is as accurate as possible to avoid consecutive faults that might affect your process control. It also enables our meters to measure reliably, even under changing or difficult process conditions. Both aspects are reflected by our claim “**Measure the facts**”.

The innovative technologies we employ for your benefit are based on our extensive R&D activities: 10 % of the >3700 KROHNE employees work in research and development. Next to sensor physics, their focus is on device communication and enabling technologies for the Internet of Things (IoT) in process industry, e.g. ethernet communication to transmit process and device diagnostic data for evaluation and process optimisation.

Our “Technology Icons” perfectly sum up the above mentioned advantages for you. You will find them highlighted within our complete portfolio in this brochure. If you don't find a matching solution for your measurement application, feel free to contact us, we look forward to solving it.



Always the right pressure. Anytime. Any process.

Pressure is one of the most commonly measured parameters in the process industry. Today, in over 40 % of all flow applications, differential pressure is still the first choice for metering liquids, gas or steam.

Almost 25 % of all liquid level measurement applications are hydrostatic pressure measurements – in case of pressurized vessels almost exclusively differential pressure level measurements.

With the release of the OPTIBAR series, KROHNE is extending its range of process instrumentation to include pressure measurement.

The OPTIBAR series includes a variety of pressure transmitters with ceramic or metal measuring cells, application specific diaphragm seals, primary elements and accessories to match a wide range of industrial process applications.

Product selection list

This table will help you in selecting the right product for your application

	OPTIBAR P 1010	OPTIBAR P 2010	OPTIBAR PM 3050	OPTIBAR DP 3050	OPTIBAR PC 5060	OPTIBAR PM 5060	OPTIBAR DP 7060	OPTIBAR LC 1010
	Page 8/30	Page 8/20/30	Page 7/8/12/20/30	Page 8/12/14/ 20/28/30	Page 6/9/20/31	Page 9/20/31	Page 7/9/14/17/ 20/28/31	Page 20/27/31
Type								
Gauge pressure	x	x	x	-	x	x	x	x
Absolute pressure	x	x	x	-	x	x	-	x*
Differential pressure	-	-	-	x	-	-	x	-
Measuring range								
Vacuum	x	x	x	o	x	x	o	-
Up to 40 bar/ 580.2 psi	x	x	x	16 bar/ 232 psi	x	x	16 bar/ 232 psi	100 mH ₂ O
Up to 100 bar/ 1450.4 psi	x	-	x	-	x	x	-	-
Up to 600 bar/ 8702.3 psi	x	-	-	-	-	x	-	-
Up to 1000 bar/ 1450.4 psi	-	-	-	-	-	x	-	-
Process connection								
Thread	x	x	x	x	x	x	x	x
Aseptic	-	x	x	o	x	x	o	-
Flange	-	-	x	o	x	x	o	x
Front flush	-	x	x	o	x	x	o	x
Material								
Diaphragm	316L	316L	316L	316L	99.996% Al ₂ O ₃	316L, C-276, Monel, Tantal, PTFE, Duplex	316L, C-276	99.95% Al ₂ O ₃
Pressure port	316L	316L	316L	316L	316L, Duplex, C-276, PVDF	316L, C-276, Monel, Tantal, PTFE, Duplex	316L, C-276	316L, Titanium grade 2
Output								
4...20 mA, 2-wire	x	x	x	x	x	x	x	x
HART®	-	-	x	x	x	x	x	x
PROFIBUS®	-	-	-	-	x	x	x	-
FOUNDATION™ fieldbus	-	-	-	-	x	x	x	-
Approvals								
SIL2/3	-	-	-	-	x	x	x	-
Ex	x	x	x	x	x	x	x	x
3-A / EHEDG	-	x/ -	x/x	x/xx**	x/x	x/x	x/x**	-
Potable water	-	-	-	-	-	-	-	x

x = suitable, o = suitable under certain conditions, - = not suitable, * = in preparation, ** = in combination OPTIBAR DS

Technology driven by KROHNE

To deliver reliable values even under difficult conditions, KROHNE products and solutions use a number of high-end technologies.

These are highlighted by the technology icons, each representing a unique and characteristic feature that also generates additional benefit for users:



OPTIBAR PC 5060

Ceramic durability

By implementing oxide ceramic diaphragms into OPTIBAR pressure devices, KROHNE is using a superior material that is permanently resistant to corrosive and abrasive media and also immune to temperature shocks.

Valuable properties are:

- **Extremely high overload resistance**
10 bar/145 psi nominal range can handle 90 bar/1305 psi pressure spikes without damage or drifts.
- **99.996 % corrosion resistance**
99.996 % Sapphire Al_2O_3 ceramic compound is corrosion resistant to almost any medium.
- **100 % vacuum resistance**
Dry cell without fill fluid – therefore temperature independent resistance to vacuum conditions.
- **100 % hydrogen resistance**
Ceramic diaphragm is not permeable by atomic hydrogen – special coatings are not necessary.
- **Robustness**
Ceramic is 10 times harder than stainless steel. Abrasion, physical impact, cavitation, water hammers do not have an effect on the sensor.
- **100 % failure detection**
In the unlikely event of a diaphragm breakage, the sensor will immediately detect the failure. Metallic diaphragms cannot give this guarantee.





Total 3D linearisation

For a robust and accurate differential pressure measurement, even under changing process conditions, each OPTIBAR DP 7060 and OPTIBAR DP 3050 differential pressure transmitter is linearised in 3 dimensions during calibration.

It means that the differential pressure (e.g. from -500 to +500 mbar/-7.25 to 7.25 psi) is not just linearised at one static pressure value, but for many values throughout the entire range (e.g. from 0 to 160 bar/0 to 2320 psi).

The full procedure is carried out several times throughout the entire ambient temperature range from -40 to +85°C/-40 to +185°F, in order to ensure that every differential pressure cell has been linearised for every possible process condition and an utmost stable and accurate measurement.



OPTIBAR DP 3050

OPTIBAR DP 7060

Total of 400 discrete measurement points

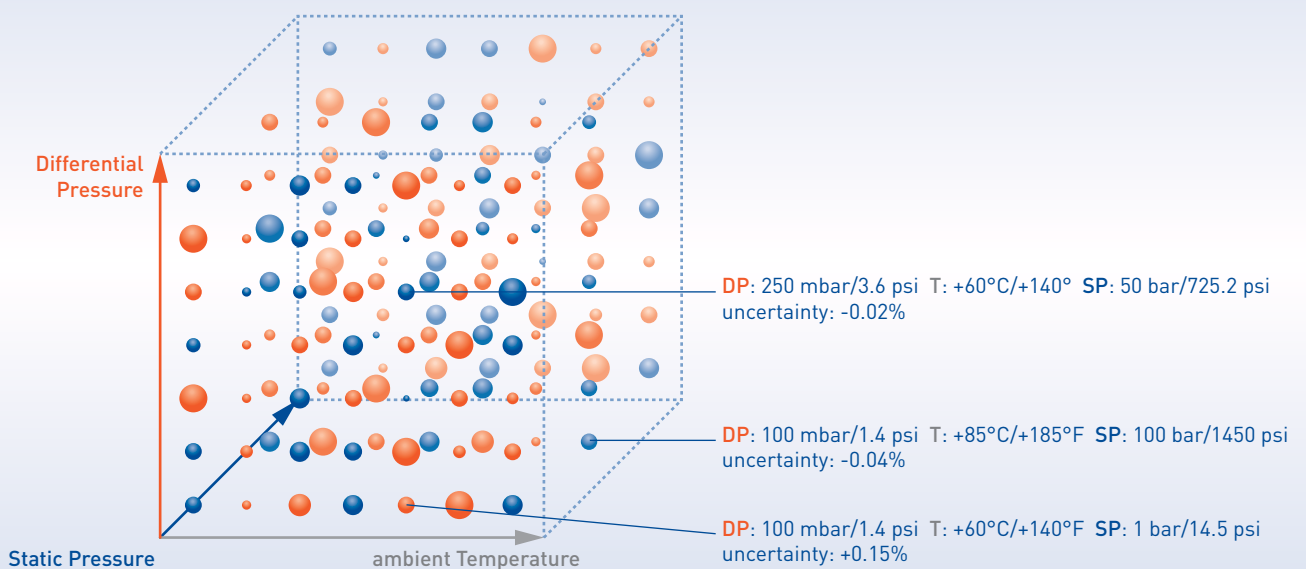

Ultra-compact pressure transmitters



OPTIBAR P 1010
For basic applications, with
recessed metallic diaphragm
up to 600 bar / 8700 psi



OPTIBAR P 2010
For hygienic applications,
with flush metallic diaphragm

Compact pressure transmitters



OPTIBAR PM 3050
For all applications, with metallic diaphragm, optional display
and adjustment module



OPTIBAR DP 3050
World's most compact differential
pressure transmitter for pressure,
level and flow applications

Accessories

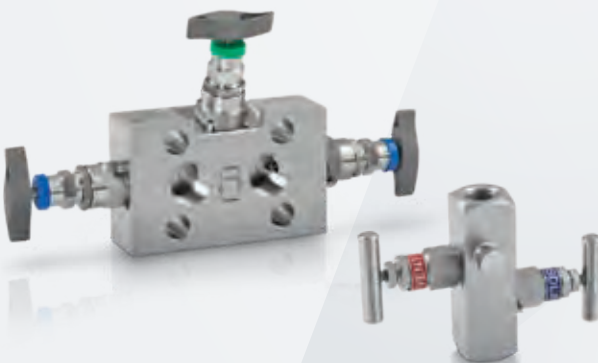

For safe and easy installation of pressure transmitters in
the process

- Manometer and barstock valves, 3-/5-way valve manifolds,
also for steam and high temperature applications
- Flange adapter according to DIN EN and ASME
- Condensate pots for steam applications
- Straight and curved connecting pipes, syphons in U- and
circular shapes

Process pressure transmitters – Modular line



OPTIBAR PC 5060
For advanced applications, with corrosion and abrasion resistant ceramic diaphragm



OPTIBAR PM 5060
For high pressure ranges and hygienic requirements, with fully welded metallic diaphragm



OPTIBAR DP 7060
Advanced differential pressure transmitter for pressure, level, flow, interface and density applications

Converter options



Sturdy ABS plastic



Standard aluminium epoxy coated



Optional display and adjustment module with background light



Heavy duty stainless steel



Electropolished stainless steel



Electronic with 4...20mA HART®, FOUNDATION™ fieldbus, PROFIBUS® PA

Sensor options



Ceramic, metallic and differential pressure sensors for every application

Remote options



Remote sensor mounting with IP68 (25 bar / 362.6 psi) rating

Process pressure measurement



Industries:

- Oil & gas
- Chemical
- Petrochemical
- Heating, ventilation & air conditioning (HVAC)
- Energy
- Metal & mining
- Food & beverage

Process pressure measurement

Process pressure transmitters are used to measure pressure in pipes or vessels.

OPTIBAR PC, PM and DP transmitters feature a modular concept that meets various requirements of modern process applications:

- Intrinsically safe and explosion proof
- Optional display and adjustment module
- 4...20 mA HART® 7 / HART® SIL 2/3, FOUNDATION™ fieldbus, PROFIBUS® PA
- Plastic, 316L, 316L hygienic, Aluminum

Measuring cells:

- Ceramic (OPTIBAR PC 5060)
- Metallic (OPTIBAR PM 5060)
- DP (OPTIBAR DP 7060)

Capacitive ceramic measuring cells (99.996 % Al₂O₃) with high long-term stability, vacuum and overload resistance are used for all common process applications. The robust ceramic diaphragm with integrated diaphragm breakage detection, covers about 80 % of all pressure applications up to +100 bar/+1450 psi gauge.

Metallic measuring cells (strain gauge or piezoresistive) with fully welded process connection are used for high pressures up to +1000 bar/+14504 psi gauge, aseptic processes, and in combination with OPTIBAR DS diaphragm seals for high temperature or corrosive applications.

Typical applications include:

- Pump dry-run protection and compressor monitoring
- Flue gas ventilation control
- Monitoring processes from low pressure to absolute vacuum
- Overload resistant level and overpressure measurement in batch tanks
- Monitoring of supply pressure in pipelines

Highlights:

- Process pressures -1...+1000 bar/ -14...+14504 psi gauge and 0...+600 bar/ 0...+8702 psi gauge absolute
- Process temperatures up to +150°C/+302°F without diaphragm seal
- Ceramic or metallic measuring cells
- Quick step response times even with small measuring ranges
- Over 250 thread, flange and aseptic process connections available
- Duplex, HASTELLOY® C-276, PVDF as well as NACE compliant materials
- Use in hazardous areas

Strengthen your competitiveness – KROHNE pressure instrumentation for hygienic applications

KROHNE OPTIBAR pressure instrumentation presents the complete line of sanitary enabled designs and materials which meet the stringent requirements of hygienic applications. This has a huge advantage for e.g. food and beverage companies who align their production processes with a focus on product safety and production reliability.

- **Hygienic design**
3-A and EHEDG standards to ensure cleanability of our products in hygienic processes
- **Hygienic process connections**
OPTIBAR instruments are available with the right process connection
- **Material selection**
KROHNE instruments are specifically designed by using GRAS (Generally Recognized as Safe) listed materials in CFR21 parts 175 through 186.

Besides regulatory requirements, KROHNE OPTIBAR pressure transmitters are tailored to the hygienic application by ensuring:

- **CIP and SIP cleaning procedure**
All KROHNE OPTIBAR pressure transmitters with hygienic process connections can be cleaned and sterilized in place;
- **Stainless steel housings**
Fully electropolished or precisely manufactured down to Ra <0.8 µm, properly protected against moisture, condensation and frequent wash-downs
- **Remote mountable transmitter**
Handling tight installation conditions or extreme washdown conditions with IP68 (25bar) rating
- **Precise and accurate measurements**
Smallest measuring ranges of 25 cm H₂O / 10" H₂O assures outstanding performance in batch or balance tank level measurements.



OPTIBAR 3050 series – Compact pressure transmitters with metallic diaphragm for general pressure, level and flow applications

The excellent performance combined with outstanding robustness of the full stainless steel construction and increased overload resistance makes this device family the optimal choice for general pressure applications.

A wide range of hygienic process connections with front flush diaphragm compliant with 3-A sanitary standard and EHEDG hygienic design places the OPTIBAR PM 3050 perfectly in food and beverage pressure and level applications

In conjunction with our proven OPTIBAR DS diaphragm seals series, the OPTIBAR PM 3050 compact pressure transmitter can be deployed in nearly every applications context of harsh chemicals or elevated process temperatures.

The OPTIBAR DP 3050 is currently the worldwide most compact pressure transmitter on the market. It offers precise differential pressure measurements for flow and level application with integrated line pressure measurement and advanced total 3D linearisation.

The optional display and adjustment module offers convenient commissioning and setup, additional buttons on the converter electronics allow for a much simpler adjustment of zero and span. The latest version of HART® 7.5 combined with a precise and stable analogue 4...20mA output signal, guarantees long-term deployment security.

The OPTIBAR 3050 series offers a complete compact pressure and differential pressure series for all general pressure, level and flow applications in outmost robust and precise fashion.



OPTIBAR PM 3050 with thread G 1/2", clamp 1 1/2"
and OPTIBAR DS series DN 50 flange connection

OPTIBAR DP 3050

OPTIBAR PM 3050 process connection variability

	Clamp DIN 32676 / ISO 2852	DRD flange	Tuchenhagen Varivent	Collar connection DIN 11851	SMS SS1145	Collar connection DIN11864-1 Form A
						
3A / EHEDG	x/x	-/-	x/x	-/x	-/-	x/x
Ultra-Compact Class	(3/4") (Ø25mm) - DN50 (2") (Ø64mm) PN16	-	Type N DN40-162 PN25	DN25 - DN50 PN40/PN25	DN38 (1 1/2") PN25	-
Compact Class	DN25 (1") (Ø50.5mm) - DN50 (2") (Ø64mm) PN25	DN50 PN 40	Type N DN40-162 PN40 Type F DN25-32 PN40	DN25 - DN50 PN40/PN25	DN25 (1") - DN50 (2") PN25	DN25 - DN50 PN40
Process Class	DN25 (1") (Ø50.5mm) - (4") (Ø119mm) PN16/10	DN50 PN 40	Type N N50-40 PN25 Type F F25 PN25	DN25 - DN65 PN40/25	DN25 (1") - DN76 (3") PN6	DN25 - DN50 PN40
	Collar flange DIN 11864-2 Form A	Collar clamp DIN 11864-3 Form A	NEUMO BioControl	Thread ISO 228 DIN 3852 front-flush	Thread ISO 228 DIN 3852 front-flush with radial O-ring	Thread ISO228 EN837-1
						
3A / EHEDG	x/x	x/x	-/x	-/-	-/-	-/-
Ultra-Compact Class	-	-	-	G1/2" - G1" PN40	G1/2" - G1" PN40	G1/4" - G1/2" PN600
Compact Class	DN40 - DN50 PN25/16	DN40 - DN50 PN25	DN25 - DN65 PN16	G1/2" - G1" PN100	-	G1/2" PN100
Process Class	DN25 - DN88.9 PN25/16	DN25 - DN40 PN25	DN25 - DN80 PN16	G1/2" - G2" PN 25/60/100	G1/2" PN100	G1/2" PN1000
	Thread ANSI 1/2"NPT-M	Thread ANSI 1/2"NPT-F	Flange ASME B16.5	Flange EN1092-1 / Flange DIN2501		
						
3A / EHEDG	-/-	-/-	-/-	-/-		
Ultra-Compact Class	1/4" - 1/2" PN600	1/2" PN600	-	-		
Compact Class	1/2" PN100	1/2" PN100	1" - 3" 300lb	DN25 - DN80 PN40		
Process Class	1/4" - 2" PN1000	1/4" - 1/2" PN1000	1/2" - 6" 1500lb	DN15 - DN200 PN250		

Differential pressure transmitters

Compact



OPTIBAR DP 3050
World's most compact differential pressure transmitter for pressure, level and flow applications

Process



OPTIBAR DP 7060
Advanced differential pressure transmitter for pressure, level, flow, interface and density applications

Primary flow elements

Orifice plates



OPTIBAR OP 1100/1110
Raised face (RF) or ring type joined (RTJ) designs



OPTIBAR OP 3100/3200
With flat sealing face and corner taps



OPTIBAR OP 4100
With annular chamber and corner taps



OPTIBAR OP 5100/5110
Assembly with measuring flanges (ASME 16.36)

Averaging pitot tubes



OPTIBAR PT 2000
With multiple impact-sensing ports



Other flow elements such as venturis, nozzels, cone and wedge meters facc. to ISO or ASME standards available on request.

Meter runs

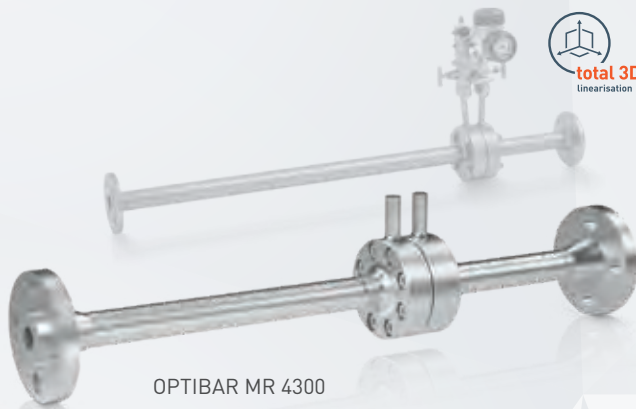

OPTIBAR MR 4300
Orifice meter run assembly with corner
taps and annular chambers



OPTIBAR MR 6300
Cone meter run with single taps

Accessories



For safe and easy installation of pressure transmitters in the process:

- Manometer and barstock valves, 3-/5-way valve manifolds, also for steam and high temperature applications
- Condensate pots for steam applications
- Fittings, seals, blind-plugs, oval flange adapter and gauge snubber

Differential pressure flow measurement

Differential pressure flow measurement

The measuring principle

For over 100 years, the process industry has used the Differential Pressure (DP) flow measurement method to determine the volume or mass flow of liquids, gases and steam in commercial use.

With DP, pressure is measured at two points across a restriction in the line – for example, a primary element. Using the Bernoulli equation, the difference in pressure between these two points indicates flow velocity and, because the pipe size is known, a volume flow rate can be calculated.

Today, DP is being constantly improved and adapted to meet the requirements of modern processes, and KROHNE is helping to lead the way.

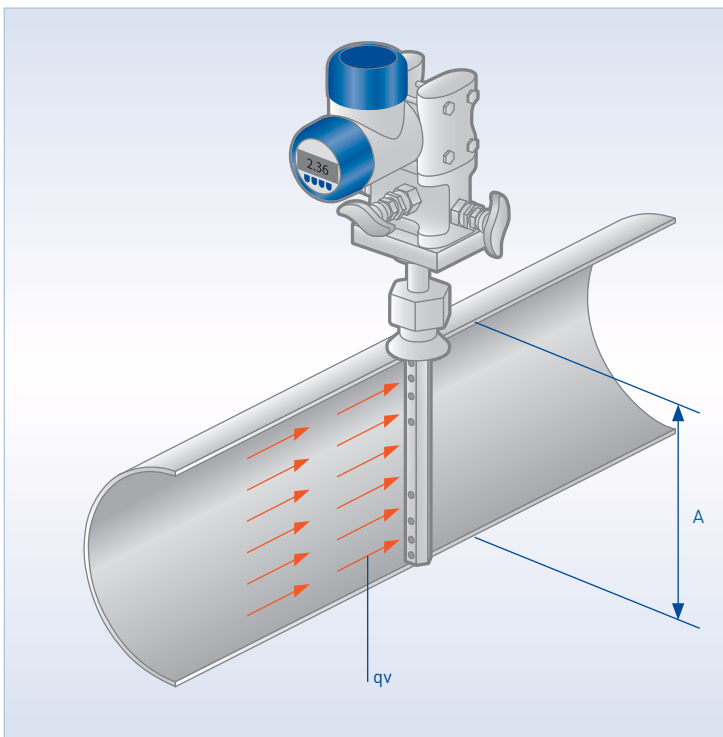

Pitot tube

As an alternative to orifice plates, the pitot tube provides a simple, cost-efficient and long-term stable flow measurement solution for:

- Applications that require a low pressure loss
- Retrofitting of existing pipelines with flow measurement
- Line sizes >DN 300/12"
- Low pressure gases

A pitot tube consisting of two chambers is placed in the pipe transversely to the direction of the flow. An upstream chamber faces the flow and a downstream chamber is placed at the back of the probe.

The impact of the medium against the upstream chamber causes an overpressure that adds to the static pressure in the pipe. Depending on its shape, a negative pressure builds up in the downstream chamber. Both pressures are transmitted to a differential pressure transmitter that converts the difference between the two chambers into an output signal.

Flow velocity is calculated using the differential pressure and medium density $v = k \times \sqrt{2 \times \Delta p / \rho}$. Volume flow is calculated from the flow velocity and the crosssection area $qv = v \times A$.

Orifice plates

Orifice plates work by restricting the flow of the liquid, gas or steam being monitored. According to the Bernoulli equation, the flow velocity increases at the restriction, and the static pressure drops. The difference in pressure at the measuring point is a measure for the flow velocity of the medium.

Volume flow is calculated from the flow velocity and the cross-section area: $qv = v \times A$

The diameter ratio $\beta = d/D$ is determined for each measuring point, allowing each one to be optimised for specific requirements, including shorter inlet/outlet runs, lower pressure losses and in some instances smaller overall uncertainty.

Orifice plate primary elements are worldwide standardised according to ISO 5167.



OPTIBAR DP 7060
with OPTIBAR OP 3100
compact orifice plate

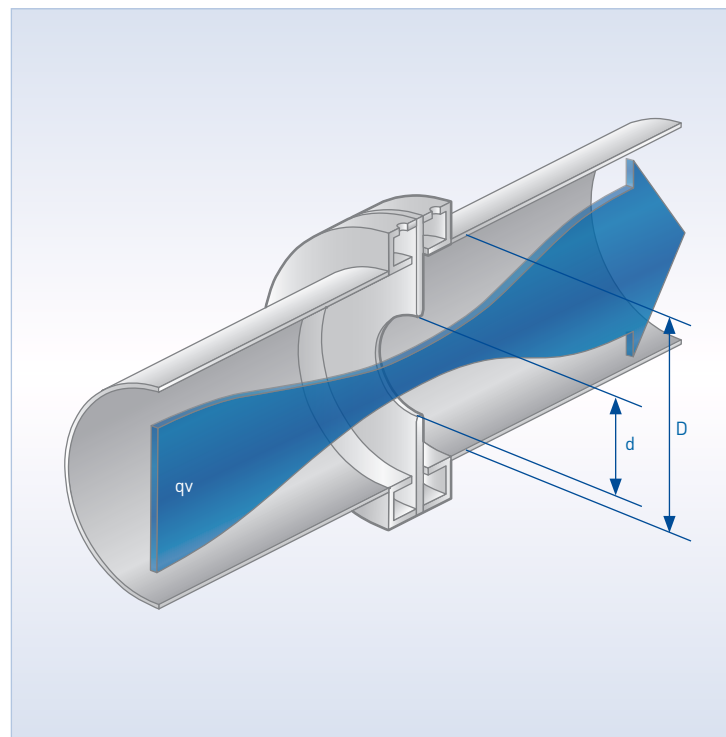

Highlights:

- Worldwide standardised flow measurement principle according to ISO 5167
- All measurement uncertainties under operational conditions are known and can be calculated
- Volume or mass flow measurement of liquids, gases or steam
- Medium temperatures -200...+1000°C/
-328...1832°F
- Process pressure up to 400 bar/
5800 psi
- Line sizes from DN25...12000/1...470"
- One pressure transmitter for all flow applications, compact or remote version
- Integrated absolute pressure measurement
- Pressure and temperature compensation available as option
- Wet-calibrated meter runs for small line sizes and low measurement uncertainty
- Optimisation of measuring points according to a given specification, e.g. short inlet/outlet, low pressure loss, small overall uncertainty, etc.
- Change of pressure transmitter without process interruption
- Compliant to PED 2014/68/EU with CE marking
- Large choice of materials for corrosive and non-corrosive mediums
- 4...20 mA HART® 7 / HART® SIL2/3, FOUNDATION™ fieldbus, PROFIBUS® PA as communication options

Introducing OPTIBAR differential pressure flow measurement products

Today, in over 40 % of all flow applications, differential pressure meters are still the first choice. With the release of the OPTIBAR series, KROHNE is extending its process instrumentation portfolio to meet this demand.

The range includes a variety of modular transmitters, application specific diaphragm seals, primary elements, accessories, valves and manifolds. This offers you the option to buy, from one source, single DP pressure transmitters as well as complete DP flow measuring points, with matched, preconfigured components, (wet) calibrated and ready to install.



Modular design concept

Complete measuring points

KROHNE will provide you with all necessary instruments for your flow measurement point: from primary elements, up to a flow computer for gas, liquid and steam calculations.

For measurement uncertainties due to changing process conditions, the flow computer holds appropriate algorithms for all primary elements. By adding temperature and pressure sensors, density compensation or gross and net energy calculations are also possible.

When commissioning a complete measuring point from us, investment costs like primary element design, component assembly up to pre-parametrisation of the differential pressure transmitter and flow computer are all less. And there are no additional costs for piping, installation and testing at the measuring point.

KROHNE's approach to design also guarantees that up to 70 % of potential leakage points will be eliminated, cutting service and maintenance costs.

Industries:

- Oil & gas
- Chemical
- Petrochemical
- Heating, ventilation & air conditioning (HVAC)
- Power generation
- Metal & mining
- Food & beverage

Complete DP flow measuring point for compensated volume/mass flow

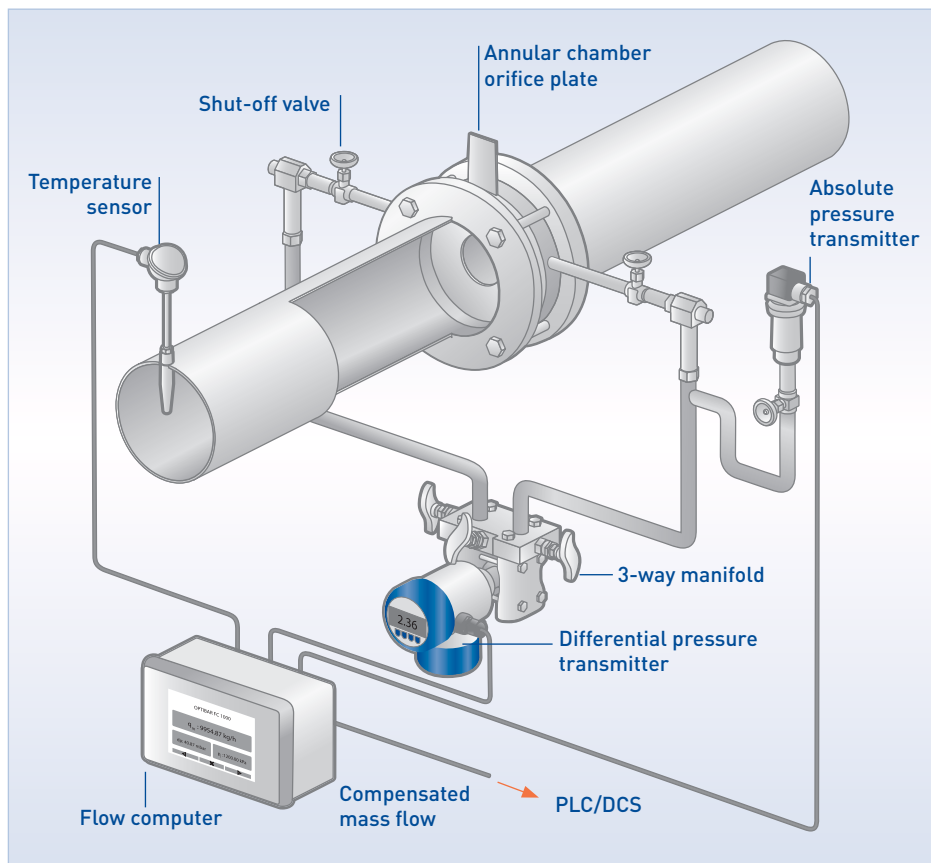

Ultra-compact pressure transmitters



OPTIBAR P 2010
For hygienic applications, with flush metallic diaphragm

Compact pressure transmitters



OPTIBAR PM 3050
For standard applications, with recessed stainless steel diaphragm and optional display module



OPTIBAR DP 3050
World's most compact differential pressure transmitter for pressure, level and flow applications

Process pressure transmitters



OPTIBAR PC 5060
For advanced applications, with corrosion and abrasion resistant ceramic diaphragm



OPTIBAR PM 5060
With fully welded metallic diaphragm for high pressure ranges and hygienic requirements



OPTIBAR DP 7060
Advanced differential pressure transmitter for pressure, level, flow, interface and density applications

Submersible probes



OPTIBAR LC 1010
Submersible level probe with ceramic diaphragm 22 mm / 1" diameter

Diaphragm seals



OPTIBAR DS series
Diaphragm seals for temperatures up to +400 °C /752 F for corrosive mediums



OPTIBAR DSD 3100
Direct attachment to OPTIBAR DP series



OPTIBAR DSD 3110
Capillary tube attachment to OPTIBAR DP series



OPTIBAR DSD 3210
Direct and capillary tube attachment to OPTIBAR DP series



OPTIBAR DSD 3220
2x Direct and capillary tube attachment to OPTIBAR DP series



OPTIBAR DSP 2000
Diaphragm seals for special applications with threaded or open connection for OPTIBAR PM series



OPTIBAR DSP 3000
Flangetype diaphragm seals for OPTIBAR PM series

All diaphragm seals can be also combined with OPTIBAR 3050 transmitter series.

Hydrostatic level measurement



Pressure transmitters for the hydrostatic level measurement

Pressure transmitters are commonly used for liquid level measurement applications. The reason for their wide spread application lies especially in the ease to install and use, their robustness in the application and their wide range of application conditions.

For level measurements in open or vented vessels, a gauge pressure or differential pressure transmitter can be used. In closed and pressurized vessels, a differential pressure measurement by a classical DP transmitter or an electronic DP system is required to compensate for the gas pressure.

Besides basic level measurements, differential pressure transmitters can be also used to measure the density or interface positions of fluids.

The OPTIBAR pressure instrumentation series offer pressure and differential pressure transmitter with metallic or ceramic diaphragms for all industry segments. Advanced diagnostics and communication protocols, easy to use software and if required engineered combinations with our OPTIBAR DS diaphragm seal series assure a perfect application fit.

In addition to the pressure transmitter series, our OPTIBAR submersible level probes are suitable for basic hydrostatic level applications in wells or tanks in water and wastewater applications.

Highlights:

- Applicable for nearly any liquid or slurry
- Process temperatures up to 400 °C/ 752 °F
- Process pressure up to 400 bar/5801 psi
- Not affected by process conditions: dust, foam, vapor, agitation, boiling or bubbles
- Process connections for all applications – also 3A and EHEDG approved hygienic connections
- Hydrostatic level measurement with automatic density compensation
- Thermal shock compensation

Hydrostatic level measurement in open or vented vessels

The measuring principle

In an open or vented vessel, the inside pressure is equal to the actual atmospheric pressure at its location. A column of liquid exerts a certain force on the base of the vessel by its own weight. A change in liquid column height causes a proportional change of force, also called hydrostatic pressure.

Using Pascal's law, the height of the liquid level can be calculated from the hydrostatic pressure P , the gravity acceleration g and the liquid density ρ .

$$P = \rho \times g \times h$$

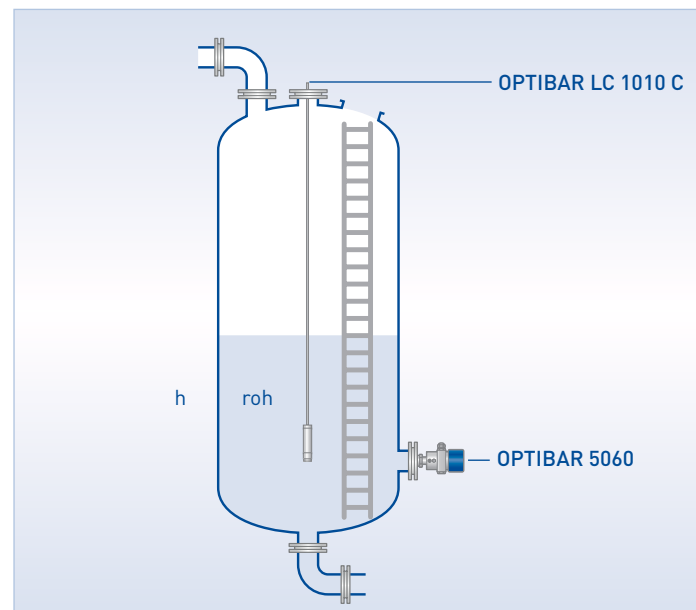

There are several OPTIBAR gauge pressure transmitters for open or vented vessels applications available:

- Entry level ultra-compact series OPTIBAR P 2010 with metallic front flush diaphragm
- Compact OPTIBAR PM 3050 and advanced process OPTIBAR PM 5060 with fully welded metallic diaphragms, also for aseptic processes.
- Process pressure transmitter OPTIBAR PC 5060 with "ceramic durability" in demanding applications for measuring ranges down to 0.25 m/10" water column.
- Differential pressure transmitter OPTIBAR DP 7060 one-sided connected with impulse piping or OPTIBAR DS series diaphragm seals.

Hydrostatic level measurement in closed or pressurised vessels

Differential pressure measurement – The measuring principle

Contrary to open or vented vessels, a gauge pressure transmitter will not perform in a closed or pressurised vessel application, since it cannot distinguish between a change of liquid level or of the pressure inside the vessel by itself.

In order to handle this type of application, a differential pressure measurement is necessary. The high pressure tap is usually located at the bottom of the vessel to measure the liquid level column plus the gas pressure on top of it. The low pressure tap is connected on the very top of the vessel to measure the gas pressure alone. The resulting pressure difference between the two taps is the hydrostatic pressure of the liquid level column inside.

The following formula is based on Pascal's Law of hydrostatic pressure, extended by the different densities of the gas phase and the fluid inside the depicted capillaries.

$$P_{\text{level}} = P_{\text{FL}} - P_{\text{G}}$$

A differential pressure measurement can be made by a single DP transmitter which is connected by impulse piping or by diaphragm seals to the vessel. Alternatively, a so called electronic DP transmitter uses two discrete gauge pressure transmitters to calculate the difference electronically.

Differential pressure transmitters for closed or pressurised vessels:

- OPTIBAR DP 7060 differential pressure transmitter for pressurised vessels up to 400 bar/5800 psi – predictable robust measurements with 3D linearisation technology.
- OPTIBAR DS series – full series of diaphragm seals with more than 10+ wetted materials to choose from.
- OPTIBAR 5060 series – advanced electronic differential pressure with metallic or ceramic technology up to 150°C

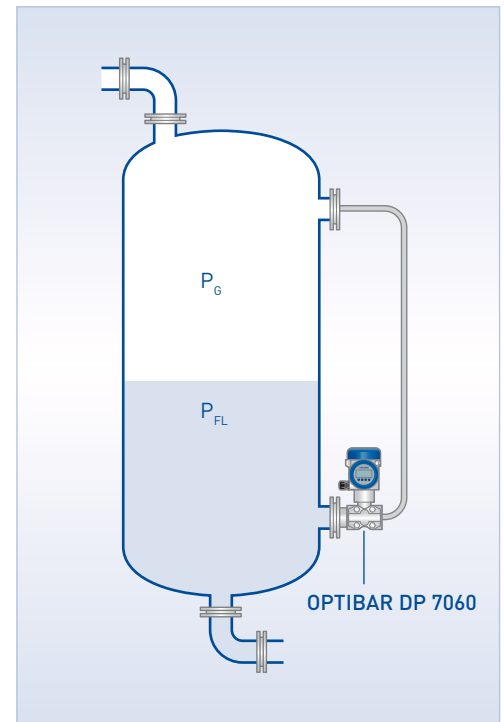

Industries:

- Oil & gas
- Chemical
- Power generation
- Food & beverage
- Metal & mining

Electronic differential pressure measurement – The measuring principle

Electronic differential pressure presents in some applications a great alternative to the use of classical differential pressure transmitters.

The measuring principle is based on two discrete gauge pressure transmitters, which are mounted in the same way as a classical differential pressure transmitter on the vessel. One transmitter, usually the one on the top, acts as so called SLAVE transmitter to measure the gas pressure in the tank. This SLAVE is electronically connected to the MASTER transmitter. This MASTER measures now the gauge pressure on the very bottom of the vessel and performs the calculation of the pressure difference in between.

$$P_{\text{slave}} = P_G$$

$$P_{\text{master}} = P_{\text{FL}} \times g \times h + P_G$$

$$P_{\text{level}} = P_{\text{master}} - P_{\text{slave}}$$

In this electronic DP configuration of the OPTIBAR 5060 series, the SLAVE sensor provides fast and synchronous measurement values to the MASTER, which acts and behaves like a classical DP transmitter in terms of setup and commissioning.

The advantages of an eDP lies especially in the efficient connection with the vessel. Smaller process connections without capillaries with a maximum distance of up to 25 m/75 ft between the top and the bottom tap, save cost and installation time. The electronic DP loses its edge in applications with higher gas pressures over a classical DP.

Density compensation

Hydrostatic level applications are require generally stable density values to maintain the overall accuracy. An electronic DP configuration in combination with an open or vented vessel allows to perform an automatic density compensation. In that function, the slave transmitter will be placed on purpose in a position, where it is being covered by at least 1m / 3ft of liquid. The converter electronics will then perform all necessary calculations internally.



OPTIBAR 5060 series in
electronic DP configuration

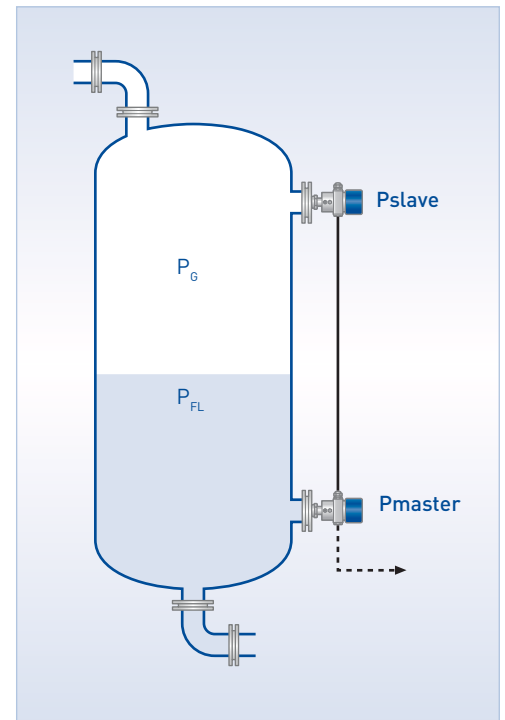

Highlights:

- Small process connections
- Mounting distance up to 25 m/75 ft with response times <125 ms
- Almost no influence by ambient temperature changes
- Up to 400 °C process temperature in combination with OPTIBAR DS series
- With SIL 2/3 certification
- Available with 4..20 mA/HART®/FF and PROFIBUS® PA
- Automatic density compensation (open vessels only)

OPTIBAR DS series diaphragm seals



Diaphragm materials:

- 316L
- Duplex Steel
- Tantalum
- Titanium
- Hastelloy® C-276
- Monel 400

Coated:

- Gold
- PFA
- PTFE (up to 200 °C full vacuum rated)
- ECTFE (HALAR)
- Rubber

Some applications require a separating diaphragm between the pressure or differential pressure transmitter and the process. Elevated process temperatures, heavy vibration, corrosive fluids or aseptic requirements make the number of use cases for the OPTIBAR DS series uncountable.

A diaphragm seal transmits the applied pressure hydraulically via a fill fluid to the pressure sensor. The OPTIBAR DSP program is specifically designed for KROHNE pressure transmitters OPTIBAR PM 3050 and OPTIBAR PM 5060, whereas the differential pressure transmitters OPTIBAR DP 3050 and OPTIBAR DP 7060 perfectly harmonize with the OPTIBAR DSD program. Only a specifically engineered and optimized system, guarantees low temperature effects and fast response times.

The OPTIBAR DS series offers the following wetted materials as standard for many process connection standards:

Diaphragm seal system schematic

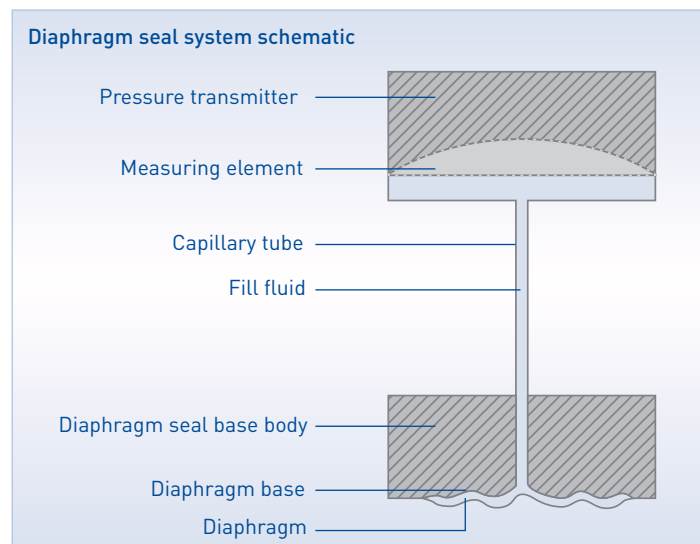

The right selection of the fill fluid considering the process temperature as well as possible low-pressure conditions is a crucial aspect of a sizing procedure for diaphragm seal systems. KROHNE OPTIBAR DS series supports this by providing for each fill fluid a comprehensive chart of low-pressure and temperature dependency to unveil potential risks of outgassing conditions early on.

Vacuum resistance chart

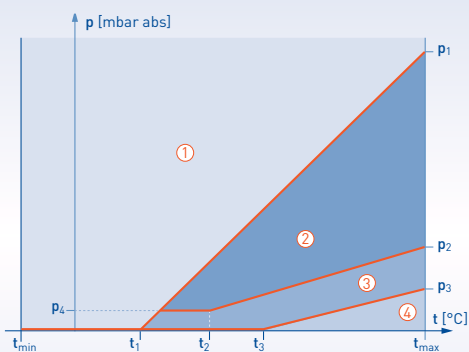

- ① Standard service
- ② Low pressure service
- ③ Vacuum service
- ④ Requires engineering support

- Silicon oil
- Silicon free oil with FDA approval
- Halocarbon oil for oxygen applications
- Water / alcohol
- Water / glycol

Hydrostatic level measurement with OPTIBAR submersible level probes

Submersible level probes are ideally suited for hydrostatic level applications of open wells and underground basins.

The measuring principle

In an open vessel, the inside pressure is equal to the actual atmospheric pressure at its location. A column of liquid exerts a certain force on the base of the vessel by its own weight.

A change in liquid column height causes a proportional change of force, also called hydrostatic pressure.

Using Pascal's law, the height of the liquid level can be calculated from the hydrostatic pressure P , the gravity acceleration g and the liquid density ρ .

$$P \text{ 0\%} = \rho \times g \times a$$



OPTIBAR LC 1010

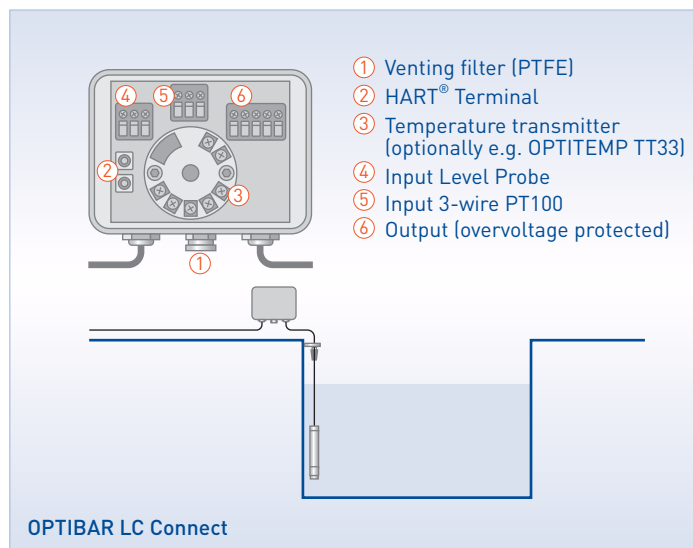







The ceramic measuring cell of the OPTIBAR LC 1010 offers a high overload and corrosion resistance and the ability to be cleaned frequently, if the application demands for it.

OPTIBAR LC Connect



An optional temperature transmitter, lightning protection, a HART® connection terminal, as well as the Gore-Tex™ vent makes this OPTIBAR LC Connect junction box perfectly suited for outside or remote location installation.

Orifice plates

	Raised face (RF) or ring type joined (RTJ) designs	With flat sealing face and corner taps	With annular chamber and corner taps	Assembly with measuring flanges acc. ASME 16.36
	OPTIBAR OP 1100/1110	OPTIBAR OP 3100/3200	OPTIBAR 4100	OPTIBAR OP 5100/5110
				
Medium	Gas, liquid and steam	Gas, liquid and steam	Gas, liquid and steam	Gas, liquid and steam
Type	Separate	Compact, separate	Separate	Separate
Sizing	EN ISO 5167: 2003; ASME MFC-3M 2007; AGA 3; ASME PTC 19.5 2004; GOST 8.586; RD 50-411-83	EN ISO 5167: 2003; ASME MFC-3M 2007; AGA 3; ASME PTC 19.5 2004; GOST 8.586; RD 50-411-83	EN ISO 5167: 2003; ASME MFC-3M 2007; AGA 3; ASME PTC 19.5 2004; GOST 8.586; RD 50-411-83	EN ISO 5167: 2003; ASME MFC-3M 2007; AGA 3; ASME PTC 19.5 2004; GOST 8.586; RD 50-411-83
Uncertainty / Accuracy	Uncertainty of C: $\pm 0.5...0.8\%$	Uncertainty of C: $\pm 0.5...0.8\%$	Uncertainty of C: $\pm 0.5...0.8\%$	Uncertainty of C: $\pm 0.5...0.8\%$
Turn down ration	6:1	6:1	6:1	6:1
Pressure loss	40...95%	40...95%	40...95%	40...95%
Max. pressure	300...2500 lbs	PN10...100	PN10...100	300...2500 lbs/600...2500 lbs
Max. temperature	+400°C/+752°F	+400°C/+752°F	+400°C/+752°F	+400°C/+752°F
Line size	1...24"	DN50...600	DN50...600	1...24"
Material primary element	316L	316L	316L	316L
Material mounting parts	n.e / Soft Steel, 316L	316L	316L	SA105, 316L
Optional temperature probe	no	no	no	no





Differential pressure transmitters for flow applications, already with integrated absolute pressure measurement for combination with all orifice plates, averaging pitot tubes and meter runs.		
	OPTIBAR DP 3050	OPTIBAR DP 7060
		
Accuracy (of calibrated span)		
Reference accuracy DP	$<\pm 0.1$ up to TD 10:01	$<\pm 0.065\%$ up to TD 10:1
Long-term stability	$<\pm 0.1\%$ within 5 years	$<\pm 0.1\%$ within 5 years
Total performance	$<\pm 0.3\%$	$<\pm 0.18\%$
Max. turn down	10:1	100:1
Reference accuracy pabs.	$<\pm 0.1\%$	$<\pm 0.1\%$
Pressure range		
Sensor	Piezoresistive	Piezoresistive
Measurement range	100, 500 mbar; 3, 16 bar/1.4, 7.2, 44, 232 psi	10, 30, 100, 500 mbar; 3, 16 bar/ 0.15, 0.4, 1.4, 7.2, 43.5, 232 psi
Line pressure	160bar/2320psi	40, 160, 400 bar/580, 2320, 5800 psi
Temperature range		
Process	40 ... +85°C/ -40 ... +185 °F	-40...+85°C/-40...+185°F
Ambient	40 ... +80°C/ -40 ... +176 °F	-40...+80°C/-40...+185°F
Configuration		
PC Tool	n/a	Free DTM, also USB interface
Software / HHT	Yes - generic HART®	Yes - generic and DD
Local	with optional display and adjustment module	with optional display and adjustment module
Material		
Housing	316L	DIN housing in 1- or 2-chamber configuration: 316L, aluminum, 316L (electro-polished), plastic (PBT)
Diaphragm material	316L	316L, Hastelloy C-276
Communication		
Output	4...20 mA HART® 7	4...20 mA, HART® 7, PA, FF
Approvals		
Ex	ATEX / IECEx Ex ia	ATEX / IECEx Ex ia, Ex d
Functional Safety	n/a	SIL 2/3

Averaging pitot tubes / Meter runs

	With multiple impact-sensing ports	Orifice meter run assembly with corner taps and annular chambers	Cone meter run with single taps
	OPTIBAR PT 2000	OPTIBAR MR 4300	OPTIBAR 6300
			
Medium	Gas, liquid and steam	Gas, liquid and steam	Gas, liquid and steam
Type	Compact, separate	Compact, separate	Compact, separate
Sizing	KROHNE standard	EN ISO 5167: 2003; ASME MFC-3M 2007; AGA 3; ASME PTC 19.5 2004; GOST 8.586; RD 50-411-83	EN ISO 5167
Uncertainty / Accuracy	<±1% uncalibrated; <±0.5% calibrated	Uncertainty of C: ±0.5...0.8% calibrated: ±0.3...0.4%	Uncertainty of C: ±5% calibrated: ±0.25...0.35%
Turn down ration (calibrated)	5:1	6:1	6:1
Pressure loss	5...12%	40...95%	40...95%
Max. pressure	PN40	150...600#/PN10...100	300...600#
Max. temperature	+400°C/+752°F	+400°C/+752°F	+400°C/+752°F
Line size	2...800"/DN50...2000	1/2...4"/DN15...10	4...24"
Material primary element	316L	316L/1.4404	316L
Material mounting parts	A105, 316L, 16Mo3	316L/1.4404	SA105
Optional temperature probe	yes	no	no

Pressure transmitters

	For basic applications, with recessed metallic diaphragm up to 600 bar/8700 psi	For hygienic applications, with flush metallic diaphragm	For all applications, with metallic diaphragm, optional display and adjustment module	World's most compact differential pressure transmitter for pressure, level and flow applications
	OPTIBAR P 1010	OPTIBAR P 2010	OPTIBAR PM 3050	OPTIBAR DP 3050
				
Accuracy (of calibr. span)				
Reference accuracy	<±0.25% FSO	<±0.25% FSO	<±0.2%/<+/- 0.1%	<±0.1%
Long-term stability	<±0.1% within 1 year	<±0.1% within 1 year	<±0.1% within 1 year	<±0.1% within 5 years
Max. turn down	n/a	n/a	10:1	10:1
Pressure range				
Sensor	Piezoresistive	Piezoresistive	Piezoresistive	Piezoresistive
Measuring range (Level, water column)	n/a	1.0...400m	4...1000m	0.25...1000m
Nominal range (Pressure)	0.1...600bar/1.45...8700psi	0.1...40bar/1.45 ... 580psi	0.4...100bar/5.8...1450psi	100, 500mbar; 3, 16bar/ 1.4, 7.2, 44, 232 psi
Pressure rating	n/a	n/a	n/a	160 bar/2320 psi
Overload resistance	5x, 4x, 2.5x	5x1bar, 4x10bar, 2.5x40bar/ 5x1.45 psi, 4x14.5psi, 2.5x580 psi	5x1bar, 4x10bar, 2.5x40bar/ 5x1.45 psi, 4x14.5psi, 2.5x580 psi	n/a
Process connection				
Thread	≥ G1/4"	≥ G1/2" front flush	≥ G1/2" front flush	1/4"NPT/1/2"NPT
Flange	n/a	n/a	with OPTIBAR DS series	with OPTIBAR DS series
Hygienic	n/a	Clamp ≥ 3/4" ISO2852, DIN32676 Varivent N	Clamp ≥ 1" ISO2852, DIN32676 ≥ DN25 acc. DIN11851 Varivent, SMS, DIN 11851, NEUMO Biocontrol, Neumo BioConnect	with OPTIBAR DS series
Other	n/a	n/a	with OPTIBAR DS series	with OPTIBAR DS series
Temperature range				
Process	-40...+125°C/-40...257°F	-40...+125°C/-40...257 °F -40...+300°C/-40...572 °F with cooling fins	-40...+150°C/-40...302°F	-40 ... +85°C/-40 ... +185 °F
Ambient	-40...+85°C/-40...+185°F	-40...+85°C/-40...+185 °F	-40...+85°C/-40...+185 °F	-40 ... +80°C/-40 ... +176 °F
Configuration				
PC tool	n/a	n/a	n/a	n/a
Software / HHT	n/a	n/a	yes - generic HART®	yes - generic HART®
Local	none-fixed measurement range	none-fixed measurement range	with optional display and adjustment module	with optional display and adjustment module
Material				
Housing	316L	316L	316L	316L
Diaphragm material	316L	316L	316L	316L
Communication				
Output	4...20mA, 0...10V	4...20mA, 0-10V, PNP/NPN switching output*, IO-link*	4...20 mA HART® 7	4...20 mA HART® 7
Approvals				
Ex	ATEX / IECEx Ex ia 1G / 1D	ATEX / IECEx Ex ia 1G / 1D	ATEX / IECEx Ex ia	ATEX / IECEx Ex ia
Functional safety	n/a	n/a	n/a	n/a
Hygienic	n/a	3A	3A, EHEDG	with OPTIBAR DS series: 3-A, EHEDG
Other	n/a	cULus*	n/a	n/a

For advanced applications, with corrosion and abrasion resistant ceramic diaphragm	For high pressure ranges and hygienic requirements, with fully welded metallic diaphragm	Advanced differential pressure transmitter for pressure, level, flow, interface and density application	Submersible level probe with ceramic diaphragm 22 mm/1" diameter
OPTIBAR PC 5060	OPTIBAR PM 5060	OPTIBAR DP 7060	OPTIBAR LC 1010
			
<±0.2%; <±0.1%; <+/- 0.05%	<±0.2%; <±0.1%; <+/- 0.075%	<±0.065%	<±0.35% FSO
<±0.1% within 5 years	<±0.1% within 5 years	<±0.1% within 5 years	<± 0.1% FSO within 1 year
20:1 (100:1)	20:1 (100:1)	100:1	n/a
Ceramic	Piezoresistive, Thinfilm	Piezoresistive	Capactive Ceramic
0.25...1000m	4...10000m	0.1...160m	1...100m
0.025...100bar/0.36...1450psi	0.4...1000bar/ 5.8...14500psi	10, 30, 100, 500mbar; 3, 16bar/ 0.15, 0.4, 1.4, 7.2, 44, 232 psi	1.0...10bar/1.45...145psi
n/a	n/a	40bar, 160bar, 400bar/580, 2320, 5800 psi	n/a
35x1bar, 9x10bar, 5x40bar/ 35x1.45 psi, 9x14.5psi, 5x580 psi	3x1bar, 3x10bar, 3x40bar/ 3x1.45psi, 3x14.5psi, 3x580psi	n/a	7x1bar, 2x10bar/7x1.45psi, 2x14.5psi
≥ G1/2" front flush	≥ G1/2" front flush	1/4"NPT , 1/2"NPT	n/a
from DN25, 1" ASME	from DN25, 1" ASME	with OPTIBAR DS series	n/a
Clamp ≥1" ISO2852, DIN32676 ≥ DN25 acc. DIN11851 DIN 11864-1, -2, -3 Varivent, SMS, DIN 11851, NEUMO Biocontrol, Neumo BioConnect	Clamp ≥1" ISO2852, DIN32676 ≥ DN25 acc. DIN11851 DIN 11864-1, -2, -3 Varivent, SMS, DIN 11851, NEUMO Bio- control, Neumo BioConnect	with OPTIBAR DS series	n/a
PMC, Swagelok VCR, etc.	with OPTIBAR DS series	with OPTIBAR DS series	n/a
-40...+ 150 °C/-40...302 °F	-40...+ 105 °C/-40 ... 221 °F	-40 ... +85°C/-40 ... +185 °F	-25 ... +85°C/-13 ... +185 °F
-40 ... +80°C/-40...+176 °F	-40 ... +80°C/-40 ... +176 °F	-40 ... +80°C/-40 ... +176 °F	-25 ... +85°C/-13 ... +185 °F
Free DTM, USB-Interface	Free DTM, also USB-Interface	Free DTM, also USB-Interface	n/a
Yes - generic and DD	Yes - generic and DD	Yes - generic and DD	Yes - generic
with optional display and adjustment module	with optional display and adjustment module	with optional display and adjustment module	none
DIN Housing in 1- or 2-chamber 316L, Aluminum, 316L (electropolished), Plastic (PBT)	DIN Housing in 1- or 2-chamber configuration: 316L, Aluminum, 316L (electropolished), Plastic (PBT)	DIN Housing in 1- or 2-chamber configuration: 316L, Aluminum, 316L (electropolished), Plastic (PBT)	316L, Titanium Gr.2
99.996% Al2O3 Ceramic	316L , Egiloy	316L , Hastelloy C-276,	99.996% Al2O3 Ceramic
4...20 mA HART® 7, FOUNDATI- ON™ fieldbus, PROFIBUS® PA	4...20 mA HART® 7, FOUNDATI- ON™ fieldbus, PROFIBUS® PA	4...20 mA HART® 7, FOUNDATI- ON™ fieldbus, PROFIBUS® PA	4...20mA with optional HART® 7, 3-wire Pt100
ATEX / IECEx Ex ia, Ex d ; Ex t	ATEX / IECEx Ex ia, Ex d ; Ex t	ATEX / IECEx Ex ia, Ex d	ATEX / IECEx Ex ia 1G
SIL 2/3	SIL 2/3	SIL 2/3	n/a
3-A, EHEDG	3-A, EHEDG	with OPTIBAR DS series: 3-A, EHEDG	n/a
DNV-GL	DNV-GL	-	DVGW drinking water

Communication technology

Drivers · Protocols · Configuration · Diagnostics

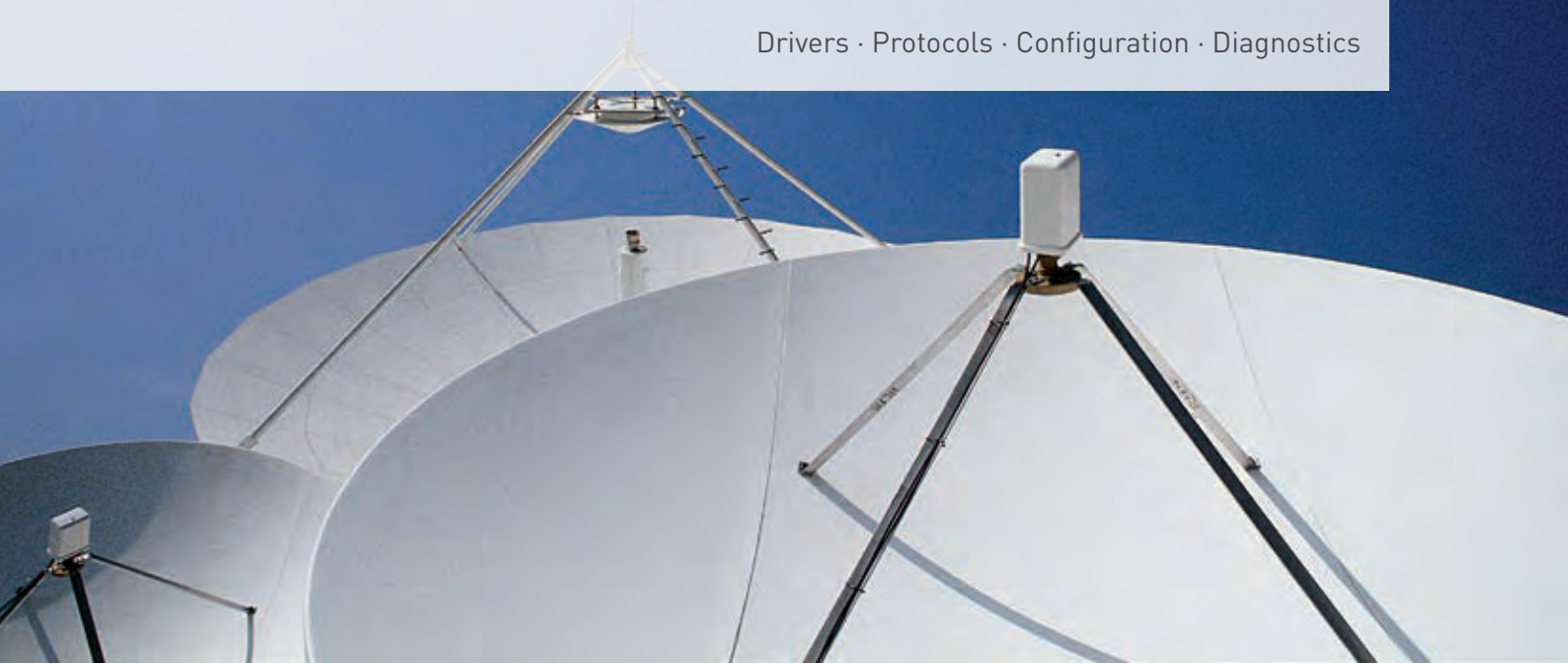

Open for the future

KROHNE is committed to making communication convenient. Which is why our field devices communicate reliably with controllers, control systems and PCs, and can also be used for a variety of control and regulating tasks.

Protocols and interfaces

We support proven and established protocols as well as new ones for certain industries, e.g. EtherNet/IP™ for the food and beverage industries, or PROFINET® for the water and wastewater sector.

Device integration

KROHNE meets all of the prerequisites for integration into modern plant asset management systems, based on integration technologies such as DD/EDD and FDT/DTM.

We are a longstanding member of PACTware™ and the FDT Group®. Since 2003, we provide DTMs and EDDs for our field devices with HART®, PROFIBUS® or FOUNDATION™ fieldbus interfaces.



Configuration and diagnostics via DTMs



Easy navigation, device status available anytime



Simple parameterisation supported by graphic elements

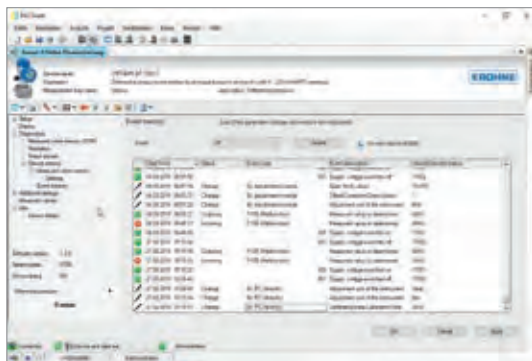

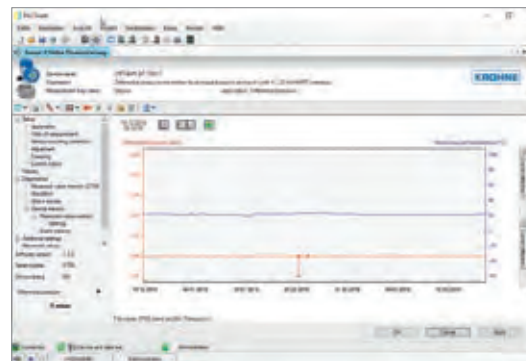

Detailed diagnostics overview with recommendations to resolve actual events

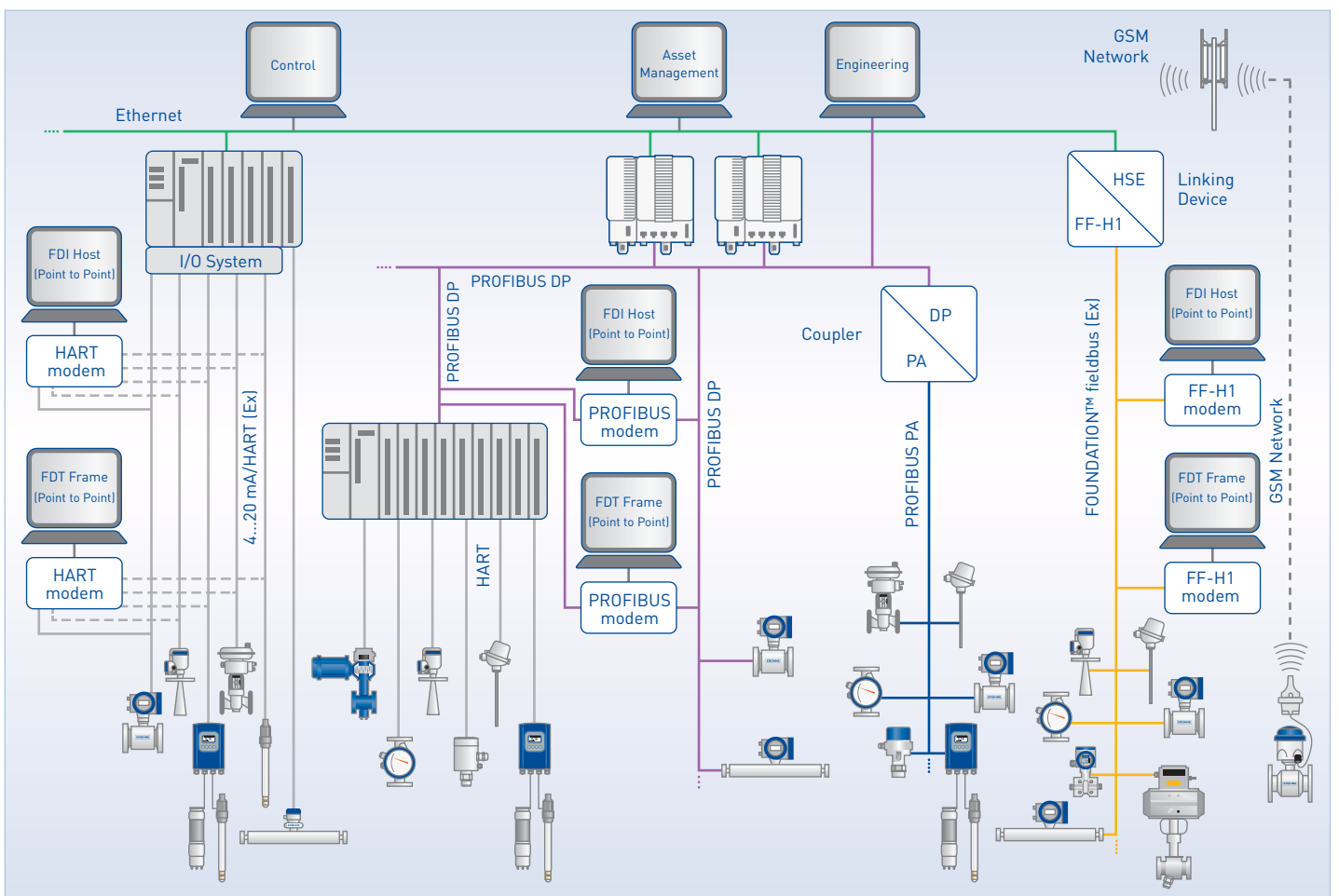

Advanced monitoring functions with optional recording of events

Fast and convenient access to process and device data from any level





Services

Project services · Online tools · Maintenance services · Metrological services · Seminars · In-situ verification · Calibration

Beyond the highest requirements

From engineering and planning to commissioning, training and documentation: our services cover all project stages, and can be offered for all enterprise sizes:

- Complete project management for instrumentation projects
- Engineering
- Commissioning
- On-site start-up
- Product training (on-site)
- Calibration, (in-situ) verification and documentation
- Maintenance services
- Seminars and trainings on various topics

Please see right page for more details on selected services.



Commissioning of flowmeters

Online tools:



PiCK

Enter the serial number and get device specific documents, e.g. manuals, handbooks, calibration certificates, etc.:
pick.krohnegroup.com

Configure It

Configure It

Configure flow and level devices and get free 2D/3D CAD data:
www.krohne-direct.com

Maintenance services

Choose from maintenance and service contracts tailored to suit all business sizes and needs:

- Spare parts and consumables
- Field service and on-site repair
- Returns
- Workshop repair
- Helpdesk

Metrological accreditation of custody transfer applications

We offer special services for metrological accreditation of measuring and loading systems for liquids and gases, according to local fiscal regulations:

- Project management from planning to commissioning, training and documentation
- For mobile and stationary measuring systems

Seminars: KROHNE Academy & KROHNE Academy online

KROHNE Academy is a series of seminars in collaboration with leading automation companies. Taking place in various countries, it addresses key operating issues, from plant safety to ways of increasing efficiency and controlling costs, and shows possible solutions. Should your interest be more towards working "hands-on" with our devices, then our service academy is what you are looking for. Learn more about KROHNE Academy at www.krohne.com

KROHNE Academy online is an online eLearning platform, focusing on industrial process instrumentation. It comprises electronic learning content with full audio, explaining measuring technology without relation to specific manufacturers. Register now for free and start your training at academy-online.krohne.com



Large team of field service engineers and technicians



MID MI-005 tanker filling system for liquefied gas



Functional safety seminar at KROHNE headquarters, Duisburg, Germany

In-situ verification

OPTICHECK is the essential tool to assure that your process measuring devices are performing according to specification. When connected to an installed meter (in-situ), it gathers data to ensure that the meter is performing within 1% of the factory calibration.

- Printed individual verification certificate
- Preventive maintenance and service features
- Storage of verification data
- Download factory calibration settings from KROHNE manufacturing database



Calibration from KROHNE: Certainty you can count on

Calibration of high pressure/high flow gas and liquid meters

For oil&gas flow metering systems, our partner EuroLoop in Rotterdam, The Netherlands, offers testing and calibration according to European MID, EN or IEC standards or OIML recommendations.

With their large closed loop facilities, single meters or complete skids can be calibrated with:

- Natural gas: 20...30,000 m³/h for sizes 6...36" up to ANSI 900 with best overall uncertainty (CMC) of 0.17%
- Liquid hydrocarbons: sizes 4...30" up to 5,000 m³/h, large range of Reynolds numbers, viscosities 1...400 mm²/s (cSt), with best overall uncertainties 0.02% for volume and 0.04% for mass

The world's most precise volumetric calibration rig for flowmeters up to DN3000/120"

Calibration is one of KROHNE's core areas of expertise. If you buy a KROHNE product, you will get a measuring device that performs most accurate with low uncertainty under real process conditions.

To achieve this, we operate more than 140 calibration facilities for volume flow, mass flow, level, temperature, density and pressure to (wet-)calibrate any device we manufacture. For example, every flowmeter is wet-calibrated using water or air as standard before leaving our facilities.

We can also provide customer specific calibration such as:

- Carry out multipoint calibrations
- Vary different parameters such as temperatures, viscosities, pressures etc.
- Use the actual medium or similar
- Build or emulate customer-specific flow geometries
- Use piping provided by the customer

For calibration we only use direct comparison of measurands (e.g. we calibrate our Coriolis mass flowmeters with a gravimetric weighing system). Our calibration rigs are the most accurate used in measuring device production worldwide: the accuracy of the reference is usually 5 to 10 times better than that of the meter under test.

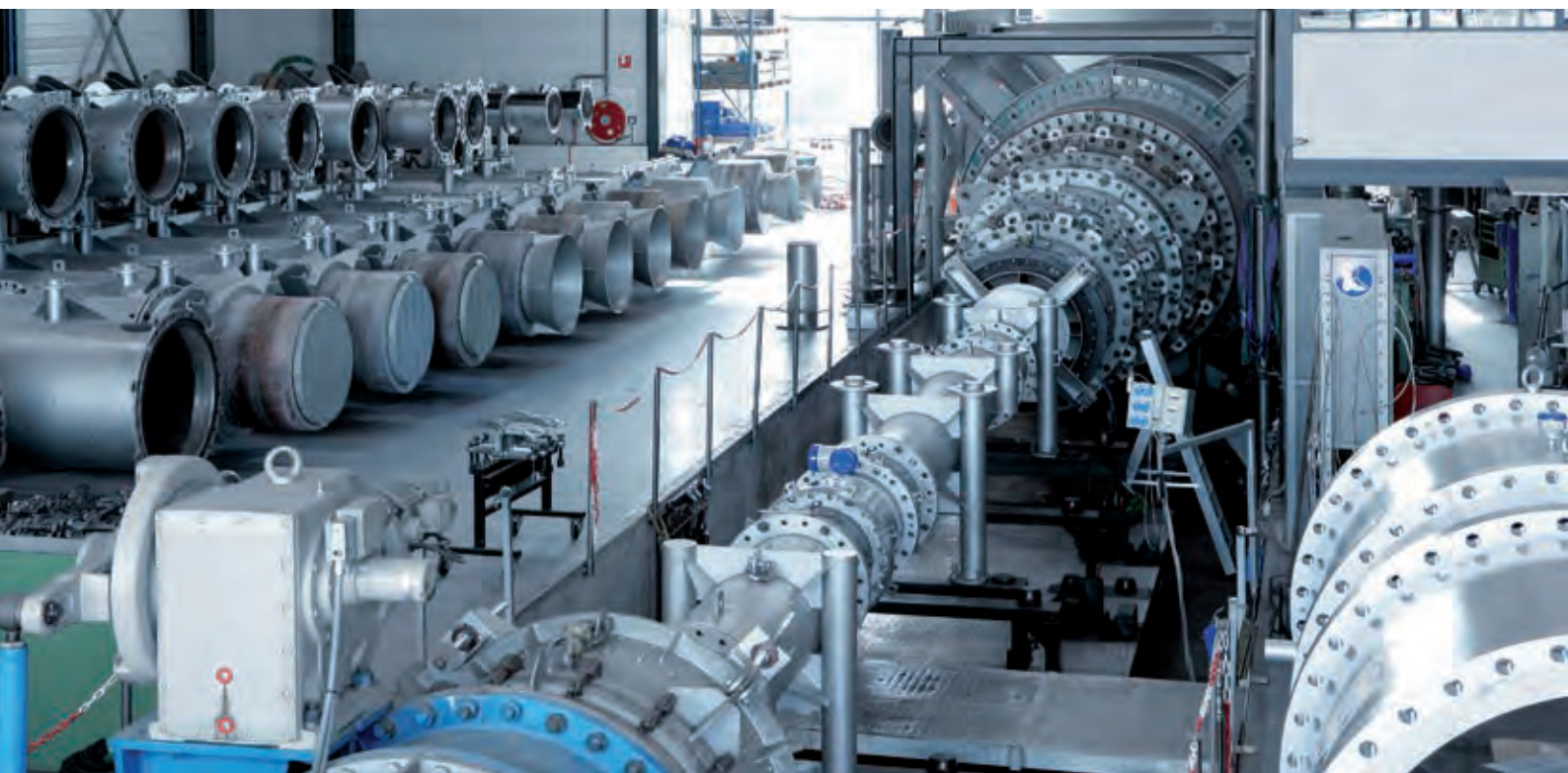

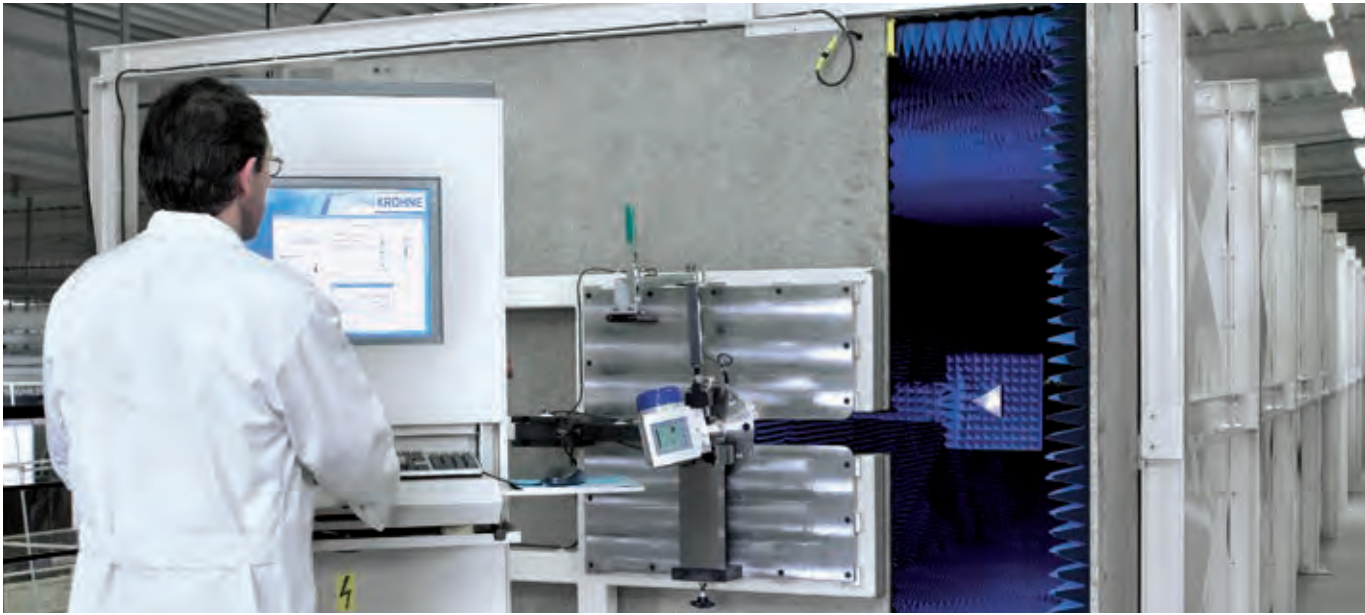

Stretch for calibration of FMCW level transmitters

Volumetric piston prover

This goes for small as well as for very large sizes: KROHNE operates the world's most precise volumetric calibration rig for flowmeters up to DN3000/120" with a certified accuracy of 0.013 %. The reference vessel is a 44 m/144 ft high tank containing almost 0.5 million litres/132,000 gal (US) of water which allows for a maximum flow rate of 30,000 m³/h/7,925,000 gal (US)/h.

Certified technology for fiscal & custody transfer applications

Our meters can be calibrated and certified according to various standards such as OIML, API, Measuring Instruments Directive (MI-001, 002, 004, 005), GOST, etc. The standards we use for calibration are ISO/IEC 17025 accredited and traceable to international or national standards. Regular inspections by national metrology institutes, round robin tests and alignments with national and international metrological standards according to ISO 9000 and EN 45000 guarantee the quality and comparability of our calibration rigs. Staff performing the calibrations are trained and given regular re-trainings to ensure quality and continuity.



KROHNE – Products, Solutions and Services

- Complete product portfolio: flow, level, temperature, pressure, process analytics
- Application-specific system solutions for various industries
- Services for instrumentation projects

ETA Process Instrumentation

www.etapii.com
sales@etapii.com
tel 978.532.1330

New England

Martech Controls

www.martechcontrols.com
sales@martechcontrols.com
tel: 315.876.9120

Upstate New York